

SCV-151H55UW

Variable Type Vacuum Capacitor (UW55 Type)

Specification

Peak Test Voltage	15 kV, peak (at 50,60 Hz/ 1 minute)
RF Working Voltage	9 kV, peak (at 13.56 MHz)
Capacitance nominal	(10) – 100 pF
Linear Variability	8.6±0.5 pF/Turn (C≥0pF)
Maximum Current	54 A, rms (at 13.56 MHz)
Tuner Turns	10.5±0.5 Turns
Tuner Operating Torque	18 N·cm
Total Length	133.5 mm
Mounting Length	90.6 mm
Outer Diameter	φ55 mm
Weight	0.7 kg



Drawing

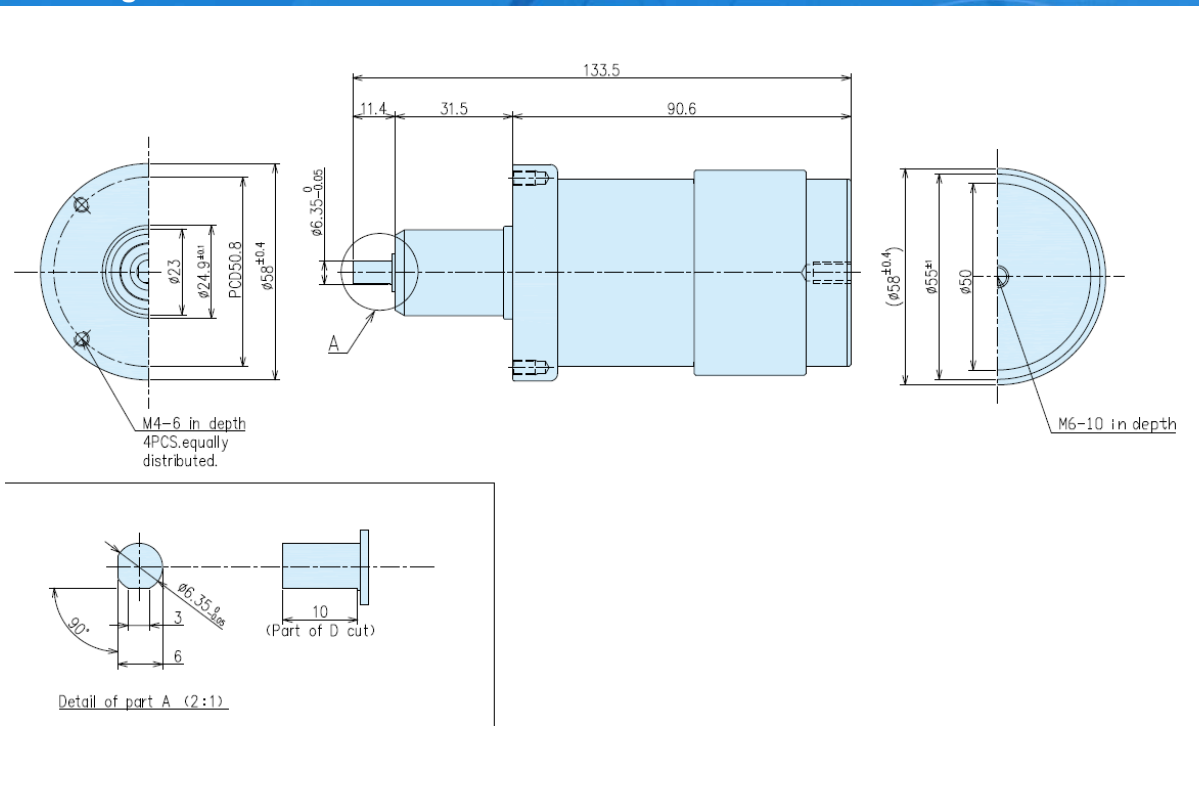

SCV-151H55UW

MEIDEN

Variable Type Vacuum Capacitor (UW55 Type)

Frequency - Current response

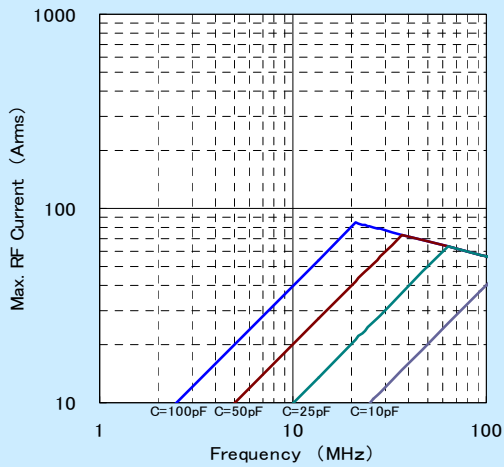

frequency - ESR

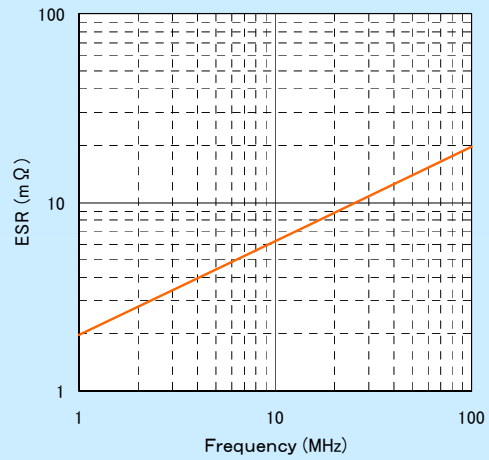

Frequency - tan δ

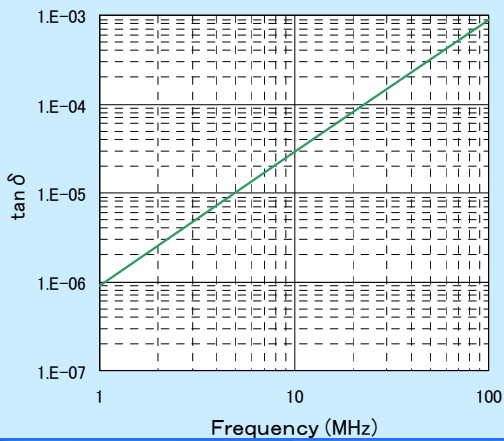

Self inductance and resonance frequency

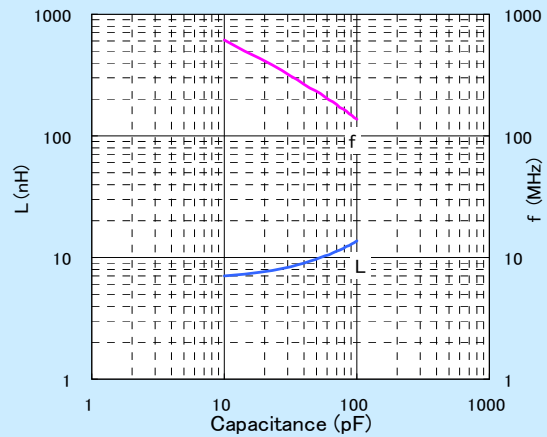

Tuner Turns - Capacitance response

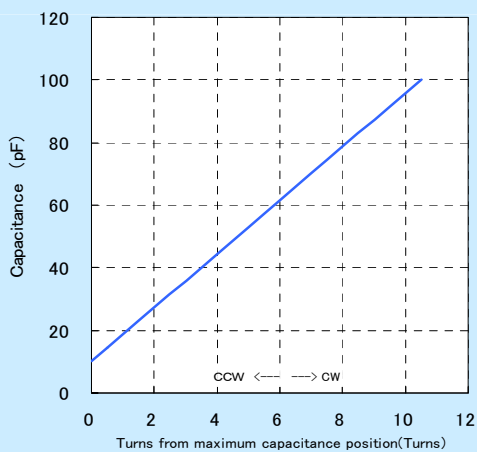

Notice:

- Current collecting system: Capacitor both-end full-face collection.
- Cooling System: Conduction.
- Permissible surface temperature: 125°C.
(The surface temperature changes with current collecting conditions and ambient temperature.)
- Ambient temperature: 25°C.